

THE MICROSCOPE

A Practical Guide

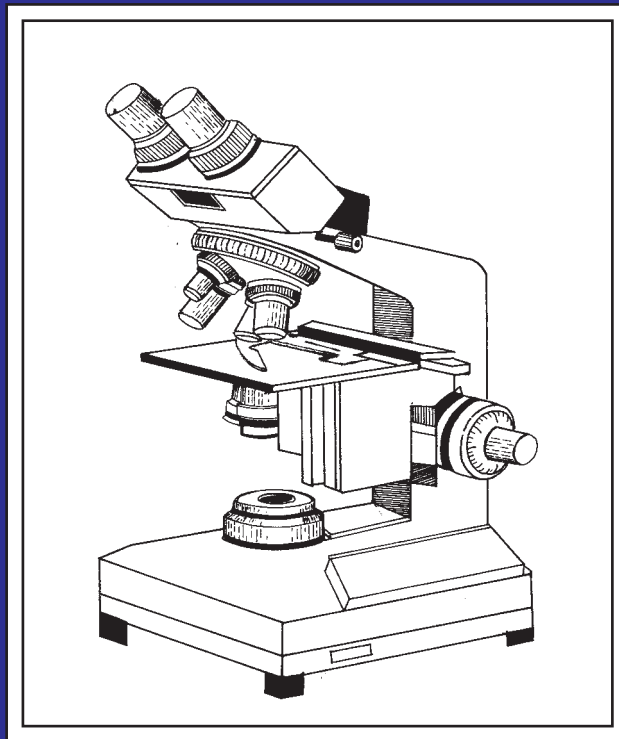

World Health Organization
Regional Office for South-East Asia
New Delhi, India
1999

THE MICROSCOPE

A Practical Guide

WHO Project: ICP TUB 001



World Health Organization
Regional Office for South-East Asia
New Delhi, India
1999

ACKNOWLEDGEMENTS

The World Health Organization wishes to acknowledge the assistance of Mr K.K. Khanna in the preparation of this document and The Research Institute of Tuberculosis (RIT), Japan for permission to use illustrations originally prepared by them. This document is also based in part on information given in *Function, Use and Maintenance of Routine Microscope*, 1986 (Zeiss, West Germany) and Chapter 6 has been adapted from *TB Microscopy* by A. Fujiki (RIT, Japan). The document was edited and designed by Byword Editorial Consultants. Dr Armand Van Deun provided helpful suggestions. Dr Thomas R. Frieden, Medical Officer (Tuberculosis), was responsible for project design and implementation.

The issue of this document does not constitute formal publication.
It should not be reviewed, abstracted or quoted without the agreement
of the World Health Organization.

Foreword

Reliable microscopy is a mainstay of primary health care, including programmes to diagnose and cure malaria and tuberculosis. For effective diagnosis to occur, the entire health care team must function effectively. The doctor must request the appropriate test and must motivate the patient to have the test done. The administrative authorities must ensure that equipment, supplies and trained staff are present. The microscopist must perform the examination and report the results to the doctor promptly and accurately. And, the doctor must make the appropriate treatment decisions. If even a single step in this process fails, the patient will not be accurately diagnosed and treated, and may develop disability, may spread the disease to others, or may die.

Laboratory technicians are thus on the forefront of primary health care and of efforts to control emerging and re-emerging infections. Our ability to detect, cure, and hence control serious epidemics such as tuberculosis and malaria depends on reliable laboratory technicians. This practical booklet is intended to help laboratory technicians to perform their work, both accurately and for a long time, by ensuring the proper use and maintenance of the microscope.

Dr Uton Muchtar Rafei
Regional Director

Contents

1	Introduction	1
2	Types of Microscopy	2
3	Parts of the Microscope	4
4	Routine Operation of the Microscope	13
5	Maintenance of the Microscope	18
6	Care of the Microscope	23
7	Materials for Care and Maintenance	24
8	Fungal Growth on the Microscope	26
9	Dos for Good Microscopy	28
10	Don'ts for Good Microscopy	32
11	Repair/Service	34
 Annexures		
I	Maintenance Record Form	36
II	Troubleshooting Guide	37

1 Introduction

The microscope is a valuable instrument. There are many small objects or details of objects which cannot be seen by the unaided human eye. The microscope magnifies the image of such objects thus making them visible to the human eye. Microscopes are used to observe the shape of bacteria, fungi, parasites and host cells in various stained and unstained preparations.

There are many different microscopes available. This guide provides:

- A brief background on microscopes and microscopy (Chapters 2–4).
- How to maintain a microscope in good condition. Chapters 5–10 describe routine maintenance procedures as well as Dos and Don'ts for proper use of the microscope.
- When and how minor repairs should be undertaken at the local level. Chapter 11 includes brief guidelines regarding minor repairs at the local level.
- A troubleshooting guide for common problems.

This guide is intended for peripheral health staff who use, maintain, and repair microscopes.

2 Types of Microscopy

Microscopes used in clinical practice are light microscopes. They are called **light microscopes** because they use a beam of light to view specimens.

A **compound light microscope** is the most common microscope used in microbiology. It consists of two lens systems (combination of lenses) to magnify the image. Each lens has a different magnifying power. A compound light microscope with a single eye-piece is called **monocular**; one with two eye-pieces is said to be **binocular**.

Microscopes that use a beam of electrons (instead of a beam of light) and electromagnets (instead of glass lenses) for focusing are called **electron microscopes**. These microscopes provide a higher magnification and are used for observing extremely small microorganisms such as viruses.

Light microscopy

Brightfield microscopy

This is the commonly used type of microscope. In brightfield microscopy the field of view is brightly lit so that organisms and other structures are visible against it because of their different densities. It is mainly used with stained preparations. Differential staining may be used depending on the properties of different structures and organisms.

Darkfield microscopy

In darkfield microscopy the field of view is dark and the organisms are illuminated. A special condenser is used which causes light to reflect from the specimen at an angle. It is used for observing bacteria such as treponemes (which cause syphilis) and leptospire (which cause leptospirosis).

Phase-contrast microscopy

Phase-contrast microscopy allows the examination of live unstained organisms. For phase-contrast microscopy, special condensers and objectives are used. These alter the phase relationships of the light passing through the object and that passing around it.

Fluorescence microscopy

In fluorescence microscopy specimens are stained with fluorochromes/fluorochrome complexes. Light of high energy or short wavelengths (from halogen lamps or mercury vapour lamps) is then used to excite molecules within the specimen or dye molecules attached to it. These excited molecules emit light of different wavelengths, often of brilliant colours. Auramine differential staining for acid-fast bacilli is one application of the technique; rapid diagnostic kits have been developed using fluorescent antibodies for identifying many pathogens.

3 Parts of the Microscope

The main parts of the microscope are the eye-pieces, microscope tube, nose-piece, objective, mechanical stage, condenser, coarse and fine focusing knobs, and light source.

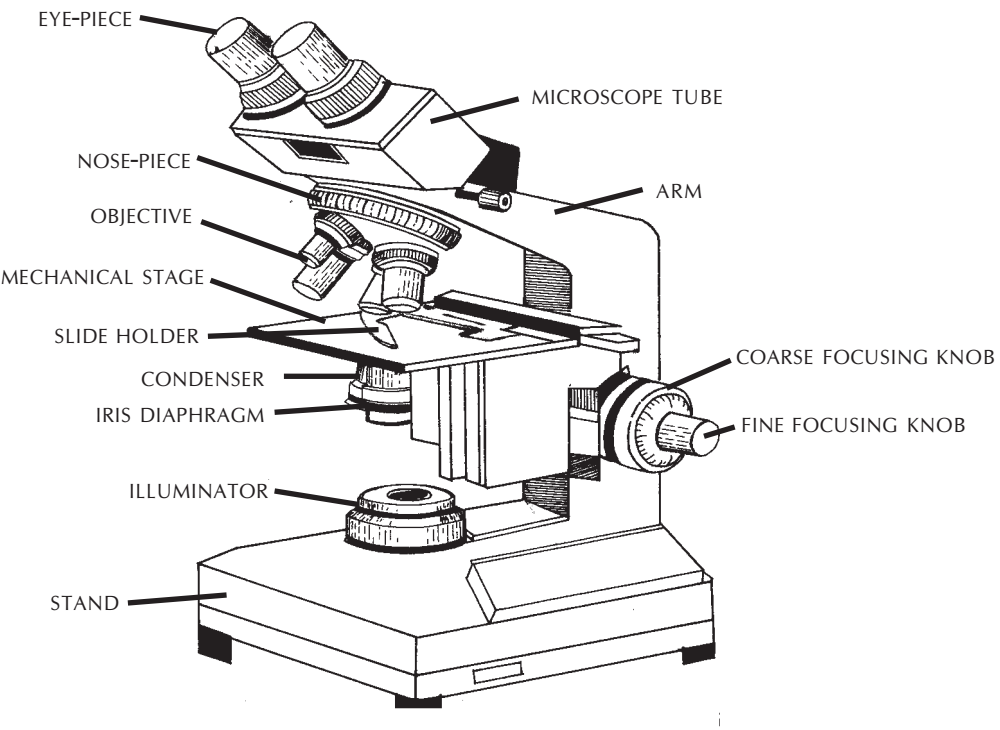

Fig. 3.1

Eye-pieces

- The specimen is viewed through the eye-piece (Fig. 3.2). It has a lens which magnifies the image formed by the objective. The magnifying power of the eye-piece is in the range 5x–20x. A movable pointer may be attached to the inside of the eye-piece.



Fig. 3.2

- In binocular microscopes, the two eye-pieces can be moved closer or farther apart to adjust for the distance between the eyes by pulling–pushing motion or by moving a knurled ring.

Microscope tube

- The microscope tube is attached on top of the arm. It can be of the monocular or binocular type. It supports the eye-piece on the upper end.

Mechanical tube length

- Mechanical tube length is the distance between the place where the objective is inserted and the top of the draw-tube into which the eye-pieces fit.

- In modern microscopes it is not tubular; it contains prisms that bend the light coming up, thus providing a comfortable viewing angle (Fig. 3.3). In a binocular tube, the light is also split and sent to both eye-pieces.

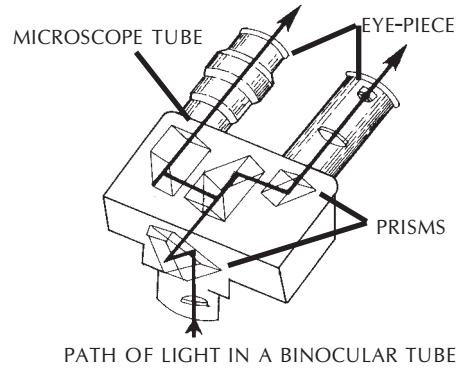

Fig. 3.3

Do not interchange the objectives of two microscopes if the specified mechanical tube length is different.

Nose-piece

- The nose-piece is attached under the arm of the microscope tube. The nose-piece (Fig. 3.4) houses the objectives and rotates them. The objectives are arranged in sequential order of their magnifying power, from lower to higher. This helps to prevent the immersion oil from getting onto the intermediate objectives.

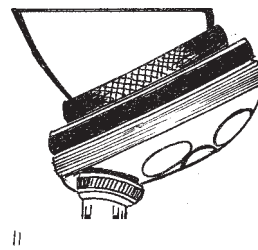

Fig. 3.4

Objectives

- The image of the specimen first passes through the objective (Fig. 3.5). Objectives with magnifying powers 4x, 10x, 40x and 100x are commonly used. The magnifying power is marked on the lens and is usually colour-coded for easy identification.

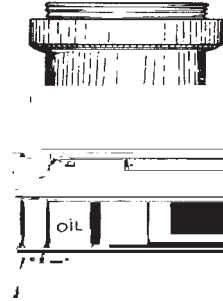

Fig. 3.5

The 100x objective is for oil immersion.

The numerical aperture (NA) is the measure of light-gathering power of a lens. The NA corresponding to the various magnifying powers of the objective is:

Magnification	Numerical aperture
10x	0.25
40x	0.65
100x	1.25

A high NA indicates a high resolving power and thus useful magnification (see page 10).

To provide the best image at high magnification, immersion oil is placed between the slide and the oil immersion objective (100x). Unlike air, immersion oil has the same refractive index as glass. Therefore, it improves the quality of the image. If immersion oil is not used, the image appears blurred or hazy.

Mechanical stage

- The mechanical stage holds the slide and allows it to be moved to the left, right, forward or backward by rotating the knobs.
- It is fitted with fine vernier graduations as on a ruler. This helps in relocating a specific field of examination.

Condenser

- The condenser (Fig. 3.6) illuminates the specimen and controls the amount of light and contrast. There are different types of condensers. Some condensers have a rack-and-pinion mechanism for up-and-down adjustment.

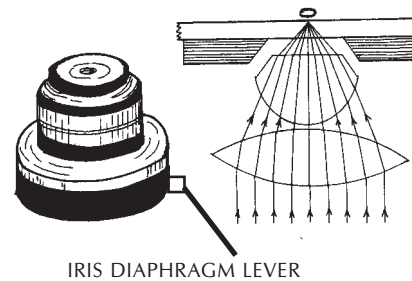

Fig. 3.6

- The NA of a condenser should be equal to or greater than that of the objective with maximum NA.
- An iris diaphragm is provided below the condenser. This adjusts the NA of the condenser when using objectives having low magnifying power.
- A swing-out type filter holder may be fitted above or under the condenser. In some microscopes the filter holder may not be swing-out type. The filter holder holds detachable filters when required.
- Condenser centring screws, when present, are used to align the condenser with the objective.
- A condenser raising knob may be present (if centring screws are not there), or the distance may be fixed.

Two-sided mirror

- A mirror (Fig. 3.7) is the simplest illuminator. The two-sided mirror provides necessary illumination through reflection of natural or artificial light. It has two surfaces, one plain for artificial light and other concave for natural light. It is supported on two sides by a fork fixed on a mount in a way that permits free rotation.

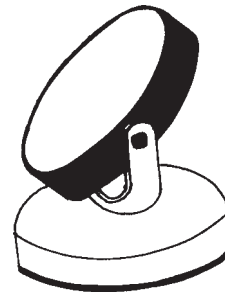

Fig. 3.7

A mirror is usually fitted on a mount or at the base of the microscope.

Built-in light sources

An illuminator is built into the base of the microscope. A halogen bulb provides the best illumination. On top of the illuminator is an in-built filter holder to fit the filter of desired quality.

Filters

- *Blue filters* are used to change the light from ordinary electric bulbs into a more natural white light.
- *Neutral density filters* are used to reduce brightness without changing the colour of the background.
- *Green filters* may be useful in some situations.

The object of AFB (Ziehl–Neelsen) microscopy is to find AFB, which are stained red by carbol fuchsin. The intensity of the red colour decreases when blue/green filters are used. Blue/green filters are, therefore, not recommended for Ziehl–Neelsen microscopy.

Immersion oil

- Immersion oil must be used with objectives having NA more than 1.0. This increases the resolving power of the objective.
- An immersion oil of medium viscosity and refractive index of 1.5 is adequate. Any synthetic non-drying oil with a refractive index of 1.5 and/or as recommended by the manufacturer should be used.

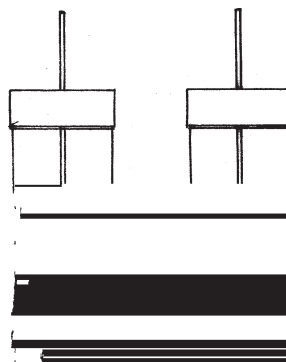

GLASS ROD SEEMS TO DISAPPEAR IN IMMERSION OIL WITH REFRACTIVE INDEX OF 1.5

Fig. 3.8

Cedar wood oil should not be used as it leaves a sticky residue on the objective. If cedar wood oil is used, particular care then needs to be taken to ensure that the objective is thoroughly and promptly cleaned with xylene after each session of use. Petrol can be used in place of xylene for cleaning if xylene is not available.

Liquid paraffin should not be used as it has a low refractive index which produces an inferior image. It is also unsuitable for scanning specimens for long periods, as is required for accurate microscopy.

Coarse and fine focusing knobs

The coarse and fine focusing knobs are used to change the distance between the specimen slide and the objective. The coarse focusing knob alters this distance rapidly and is used to bring the specimen into the field of view using an objective having low magnification power. The fine focusing knob changes the distance very slowly and permits better viewing of the object. One revolution of the fine focusing knob should generally move the mechanical stage by 100 μm . The movement should be smooth and free from jerks.

Halogen lamp

Halogen lamps are low wattage, high intensity lamps and are the preferred light source. Though costlier, these have the following advantages over tungsten lamps:

- emit white light
- have higher luminosity (brighter)
- have compact filament
- have longer life.

Functioning of the microscope

There are three main optical pieces in the compound light microscope. All three are essential for a sharp and clear image. These are:

- Condenser
- Objectives
- Eye-pieces.

The condenser illuminates the object by converging a parallel beam of light on it from a built-in or natural source. The objective forms a magnified inverted (upside down) image of the object. The eye-piece magnifies the image formed by the objective. This image is formed below the plane of the slide.

The total magnification of the microscope is the product of the magnifying powers of the objective and the eye-piece.

For example, if the magnifying power of the eye-piece is 10x and that of the objective is 100x, then the total magnification of the compound light microscope is: $10x \times 100x = 1000$ -fold magnification.

4 Routine Operation of the Microscope

- Ensure that the voltage supply in the laboratory corresponds to that permitted for the microscope; use a voltage protection device, if necessary.

- Turn on the light source of the microscope (Fig. 4.1).

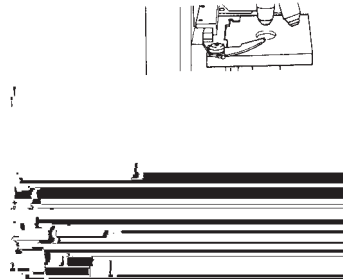

Fig. 4.1

- With the light intensity knob, decrease the light while using the low magnification objective.

- Place a specimen slide on the stage. Make sure the slide is not placed upside down. Secure the slide to the slide holder of the mechanical stage (Fig. 4.2).

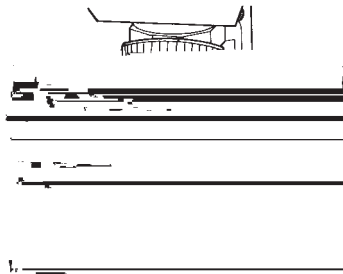

Fig. 4.2

- Rotate the nose-piece to the 10x objective, and raise the stage to its maximum.
- Move the stage with the adjustment knobs to bring the desired section of the slide into the field of view.

- Focus the specimen under 10x objective using the coarse focusing knob and lowering the stage (Fig. 4.3).
- Make sure the condenser is almost at its top position. Centre the condenser using condenser centring screws if these are provided in the microscope. For this take out one eye-piece and while looking down the tube, close the iris diaphragm till only a pin-hole remains. Check if this is located in the centre of the tube.

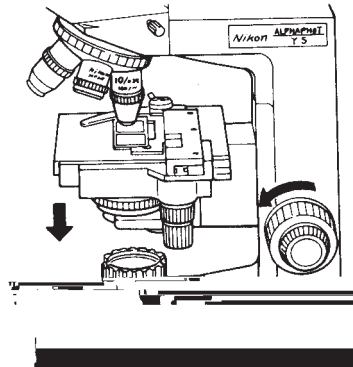

Fig. 4.3

- Open the condenser iris diaphragm to 70%–80% to adjust the contrast so that the field is evenly lighted (Fig. 4.4) .

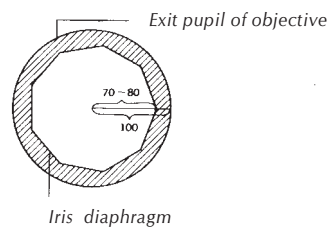

Fig. 4.4

Many modern microscopes have pre-centred and fixed condensers. In these no adjustments are required. To reduce glare adjust the opening of the iris diaphragm.

- Adjust the interpupillary distance till the right and left images become one (Fig. 4.5).

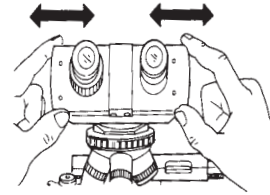

Fig. 4.5

- Focus the image with the right eye by looking into the right eye-piece and turning the focusing knob (Fig. 4.6).

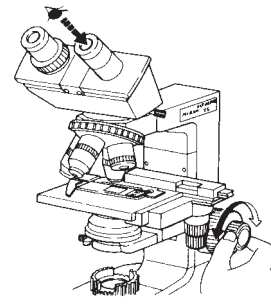

Fig. 4.6

- Focus the image with the left eye by looking into the left eye-piece by turning the diopter ring (Fig. 4.7).

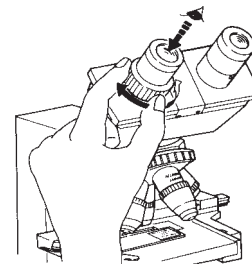

Fig. 4.7

- Put one drop of immersion oil on the specimen (Fig. 4.8).

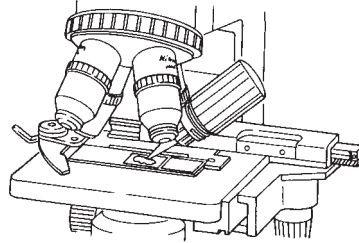

Fig. 4.8

- Change to 100x objective (Fig. 4.9).

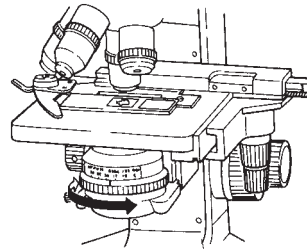

Fig. 4.9

- Increase the light by turning the intensity knob until a bright but comfortable illumination is achieved.
- Focus the specimen by turning the fine focusing knob.
- When the reading/observation has been recorded, rotate the objective away from the slide.
- Release the tension of the slide holder, and remove the slide.
- If immersion oil was used, wipe it from the objective with lens paper or muslin cloth at the end of each session of use. In general, avoid wiping the objective except when it seems to be dirty.
- Turn off the light.

- Cover the microscope when not in use and take necessary precautions against fungus.

Eye strain should not develop if the microscope is used properly.

Never adjust the stage upward while looking through the eyepiece. It will cause the objective to push against the slide and may damage it.

Only the 100x objective can be used for viewing under immersion oil. All other lenses are to be used without immersion oil; keep them dry and avoid applying oil or any liquid to these lenses.

5 Maintenance of the Microscope

(NOTE: In all cases, the manufacturer's manual should be consulted for specific instructions.)

Installation and storage

- Install the microscope on a sturdy, level table. Equipment and instruments which generate vibrations, such as centrifuges and refrigerators, should not be placed on or near this table.
- The height of the table should be convenient for the user. As an alternative or in addition, an adjustable stool should be made available to make microscopy comfortable.
- The table should be away from water, sinks, and racks containing chemicals, to prevent damage to the microscope from splashes or spills.
- If the microscope does not have a built-in light source then the table should be placed near a window away from direct sunlight and arrangements made for the provision of a lamp.
- In so far as is possible, the microscopy room should be free from dust and should not be damp.
- If the microscope is to be used every day, do not remove it from the site of installation, provided security is assured.
- When the microscope is not in use, keep it covered with a polythene or plastic cover and take necessary precautions against fungus.

Dust is the worst enemy of the microscope. Always keep the microscope properly covered. Fungus is also a major problem. Always keep the microscope in dry surroundings.

- In humid areas, store the microscope every night in a cabinet fitted with an electric bulb (5 W or 40 W). This is switched on at night to reduce humidity.
- If the microscope is used intermittently and requires storage for prolonged periods, keep it in an air-tight plastic bag with about 100g of drying agent. Remember to regenerate/replace drying agents (silica gel or dry rice) fortnightly or as needed.
- If only a wooden box is available, keep the microscope in it with some dry silica gel or dry rice (see page 25).

Maintenance of lenses

Avoid collection of dust and immersion oil on the objectives and eye-pieces by keeping the microscope covered. Do not allow immersion oil to touch any of the objectives other than the oil immersion objective. Always keep the eye-pieces in place to protect the inner surface of the objective. Close the holes of missing objectives in the nose-piece by using special caps that are provided, or by sealing with adhesive tape.

Removal of dust from lenses

Check for dust or dirt on the lenses (eye-pieces, objective, condenser and illuminator lenses) if the image appears hazy or with black dots.

- If the black dot moves when the eye-piece is rotated, this means that the dust is on the eye-piece.
- If the black dot moves when the slide moves then the dust is present on the slide.
- If these two are ruled out, presume that the dust is on the objective. Dust on objectives shows as dots if it is inside. If the dust is outside the objective it shows as a hazy image.

Do not remove the dust from the lenses by wiping these with a cloth as this can scratch the lens and damage it permanently. Use an airbrush or a camel-hair/artist's brush.

Dust can be removed with a camel-hair/artist's brush or by blowing air over the lens with an airbrush. Dust on the inner surface of the objective can be removed by using a soft camel-hair brush (artist's brush).

Removal of oil from lenses

The presence of oil on the lenses produces a hazy image. The localization of oil can be done by the same method as has been described above for localization of dust.

Oil should be removed with the help of lens paper using lens cleaning fluid as recommended by the manufacturer. This can be applied gently with lens paper. Do not use force to remove oil as this might result in scratches on the lens.

If the field of view is not clear despite cleaning, and the microscope works well with another lens, then the lens has been permanently damaged and must be repaired or replaced.

If the field of view is not clear even after changing the lenses (objective and eye-piece) there is probably dirt or fungus on the tube prisms. These can be checked by removing the eye-pieces, and examining the upper part of the microscope tube with the light fully open. Fungus is seen as threads, dots or a woolly layer.

Inspection of the objective

- Carefully unscrew the objective from the nose-piece.
- Gently remove one eye-piece to use as a magnifier (or use a magnifying glass).
- Grasp the objective in one hand with the front lens face up.
- Hold the eye-piece in the other hand with the top lens facing down.
- Bring the eye-piece very close to your eye and focus on the objective. Change the angle of the objective so that light can reflect off its surface. The two lens surfaces will be about 2.5 cm apart. Try to avoid letting them touch each other.
- Inspect the objective for scratches, nicks, cracks, deterioration of seal around the lens, or oil seepage into the lens.

Maintenance of mechanical moving parts

Mechanical moving parts of the microscope may become too stiff or too loose.

Stiffness is due to accumulation of dust or because the sliding channel has become rough. This problem can be overcome by cleaning, polishing and lubricating the sliding channel and the rack and pinion. First remove the dust with a camel-hair/artist's brush or by blowing air; clean it with a solvent such as petrol, polish with metal polish and apply high quality silicone grease to lubricate the moving parts.

Stiff movements may also be due to mechanical bending of some part. Rectify the fault or call the service engineer.

With prolonged use, the up and down movement of the mechanical stage becomes **loose**. The stage, therefore, slides down during examination resulting in loss of focus. Adjust the tension with the tension adjustment device as recommended by the manufacturer.

Maintenance of light source

The supply of voltage (110 V or 220 V) must always conform to that specified for the microscope. Adequate number of spare bulbs and fuses should be available. Do not touch the bulbs with bare hands. Provide adequate ventilation to take care of heat generated by light. Provide voltage protection, if necessary. Before switching the lamp on, adjust the variable voltage regulator to minimum. Switch on the lamp and slowly increase the voltage until the desired intensity is achieved.

6 Care of the Microscope

After daily use

- Bring the variable voltage regulator setting to the minimum before turning off the lamp. Turn off the light source of the microscope.
- Gently wipe the immersion oil off the objective, condenser and mechanical stage with lens paper or muslin cloth.
- Replace the cover of the microscope and take necessary precautions against fungus.

Each month

- Use an air brush to blow away dust. Clean the objectives, eye-pieces, and condenser with lens cleaning fluid. Do not put fluid directly on the lenses; instead, apply it to the lens paper and then clean.
- Remove the slide holder from the mechanical stage and clean.
- With a tissue moistened with water, wipe the dust off the body of the microscope and the window of the illuminator in the base of the unit.

Every six months

Thoroughly inspect, clean, and lubricate the microscope after consulting the manufacturer's manual. This should preferably be done by professional service personnel.

7 Materials for Care and Maintenance

(NOTE: In all cases, the manufacturer's manual should be consulted for specific instructions.)

Lens cleaning fluid

Lens cleaning fluid is used to clean optical surfaces. It does not harm the coatings of the lens and does not soften the sealers and cements around the lens.

Consult the manufacturer's manual for specifications regarding lens cleaning fluids as requirements are different depending on the microscope.

Ethyl ether and xylene are the commonly used lens cleaning fluids. Petrol can be used if xylene is not available. Ethyl ether is extremely flammable and xylene is toxic. These must, therefore, be stored safely to avoid any accident. Alcohol, acetones or any other ketones should not be used, unless recommended by the manufacturer, since these may dissolve the sealants around the lens.

Lens paper

Lens paper is specially prepared paper free from abrasive particles. If lens paper is not available, muslin cloth or soft silk cloth may be used.

Light bulbs and fuses

Maintain a sufficient supply of bulbs and fuses for every microscope.

Air brush

Use air to blow away particles from the surface of the microscope. Be careful when cleaning the mechanical stage as tiny pieces of broken glass may be present. A simple air brush (Fig. 7.1) can be made in the laboratory by attaching a Pasteur pipette to a rubber bulb.



Fig. 7.1

Microscope cover

After use, the microscope should be covered with a polythene or a plastic bag and necessary precautions against fungus should be taken (see Chapter 8).

Drying agents

Keep dry silica gel or any other drying agent in the microscope cabinet to reduce moisture. Regenerate the drying agent when necessary. Dry silica gel (blue in colour) absorbs moisture inside the box. Its colour changes to pink when it is unable to absorb more moisture. When this occurs, it should be dried by keeping in a hot air oven or heating in a saucepan. When completely dry it regains its original blue colour and can be reused.

If silica gel is not available, disposable and cheap drying agents like salt and rice can be used. Rice is convenient and inexpensive. As soon as it is no longer dry and crisp, it must be replaced.

This method will work only if the cabinet or box closes tightly. If no good closed space is available, a plastic bag may be used provided it is made of thick polythene and sealed each time. If a lamp for heating is used at night, then simultaneous ventilation is an advantage, and the space does not have to be closed tightly.

8 Fungal Growth on the Microscope

Fungus is common in hot and humid climates. These conditions prevail for most of the year in South-East Asia, and therefore precautions are necessary. Fungal growth should be suspected when part or all of the image becomes unclear or hazy. If fungal growth is advanced, the image becomes dim and hardly anything can be seen.

Fungus can attack all microscopes within few years if no precautions are taken, even if “anti-fungal treated” lenses are used.

The lenses, the eye-piece tube and prisms of the microscope are often the first places for fungal growth. The eye-piece tube can be checked by taking out the eye-pieces and inspecting the inner part of the tube with the light on. Cleaning of the eye-piece tube is difficult and should be done only by authorized personnel.

Factors facilitating fungal growth

- Hot and humid environment
- Storage cabinets made of wood, leather or plastic without a desiccant
- Storage in cupboards or drawers
- Storage in small, dark unventilated rooms.

How to prevent fungal growth

- Store the microscope every night in a cabinet fitted with an electric bulb (5 W or 40 W). The bulb should be preferably fitted on the top of the cabinet so that it is near the tube (head of the microscope). Keep the bulb switched on overnight. If this technique is used, the cabinet should have holes for ventilation so that air flows freely.

or alternatively,

- Use a drying agent, such as silica gel or rice, continuously. When using a drying agent be sure the microscope is confined to a wooden box or air-tight plastic bag. Be sure to regenerate/change the drying agent as described on page 25.
- Clean the microscope regularly. Wear thin cloth/latex gloves when handling microscope lenses. Otherwise, fungus may grow where fingerprints were left.
- If none of the above are feasible, keep the microscope in a place with good circulation of air. When not in use, the microscope can be kept in direct sunlight for a few hours to reduce moisture.
- Although generally not feasible in peripheral centres, continuous air conditioning is very effective in preventing fungal growth. Keeping microscopes in AC stores is only recommended for prolonged storage, not if they have to be taken out daily.

How to remove a film of fungus

Remove fungal growth as soon as it appears and frequently thereafter. Moisten a wad of cotton wool with a fungus cleaner which is recommended by the manufacturer. Use lens cleaner if fungus cleaner is not available. Clean the lens by moving the cotton wool in circles or back and forth under moderate pressure. If necessary, repeat the same procedure with a fresh wad of cotton wool. Wipe the lens with a fresh dry wad of cotton. Contact the service engineer if this does not remove fungal growth.

Do not attempt to clean parts of the microscope which are not accessible (such as prisms) and which may require disassembling the instrument.

9 Dos for Good Microscopy

- Place the microscope on a level vibration-free surface. Never keep it on the surface where a centrifuge is placed. Also, keep it away from refrigerators and air conditioners (Fig. 9.1).

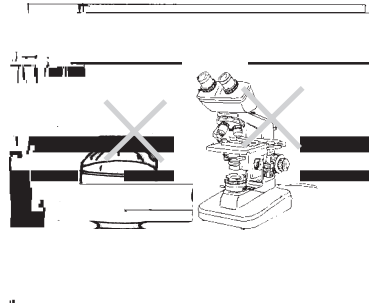

Fig. 9.1

- Store the microscope in a cabinet fitted with an electric bulb (5 W or 40 W) which is switched on in order to reduce humidity (Fig. 9.2).

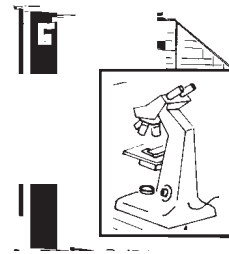

Fig. 9.2

- Always carry the microscope with one hand supporting the base and the other hand around the arm (Fig. 9.3).

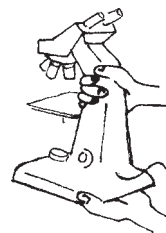

Fig. 9.3

- Place the microscope in a location from which it need not be moved frequently (Fig. 9.4).

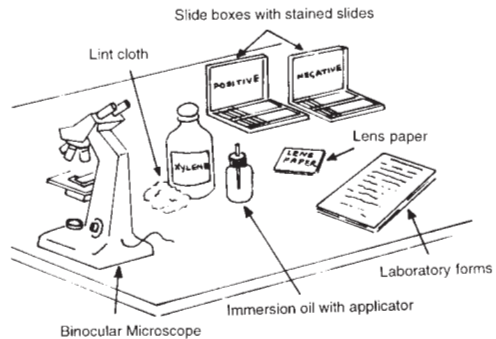

Fig. 9.4

- Turn the nose-piece to the objective with lowest magnifying power before removing the slide and when the microscope is not in use (Fig. 9.5).

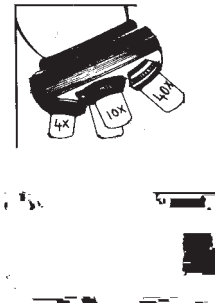

Fig. 9.5

- Cover the microscope when not in use, taking all precautions to prevent growth of fungus (Fig. 9.6).

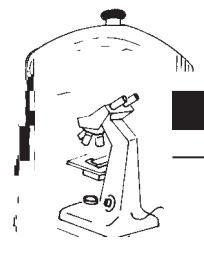

Fig. 9.6

- Adjust the variable voltage regulator setting to minimum before switching on the lamp and increase the voltage slowly until the desired intensity of light is achieved.
- **Always keep the condenser up**, adjusting the light intensity by using the illuminator regulator. Remember to adjust the iris diaphragm opening to about 80% of its maximum when using the immersion objective, or to slightly less for lower power objectives.

- Always place the slide with the specimen side up (Fig. 9.7).

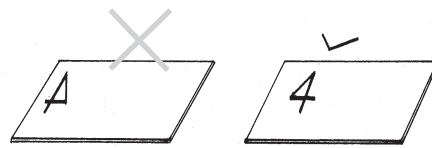

Fig. 9.7

- For focusing, always turn the stage up toward the objectives while looking from the side and not through the eye-pieces, so as to avoid turning it up too far and damaging the objective. Only thereafter do the actual focusing, looking through the eye-pieces, by lowering the stage away from the objectives.

- Always keep the immersion oil bottle capped and free from dust and debris (Fig. 9.8).

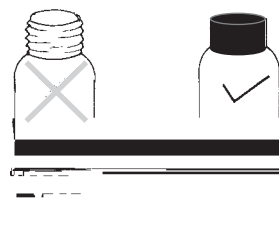

Fig. 9.8

- Use a dropper and not a glass rod to put immersion oil on the slides without touching it (Fig. 9.9).

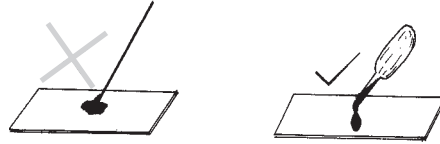

Fig. 9.9

- Gently wipe off immersion oil from the lens after each session of use with lens paper or muslin cloth. This is sufficient if good quality oil is used (use synthetic oil recommended by the manufacturer) (Fig. 9.10).

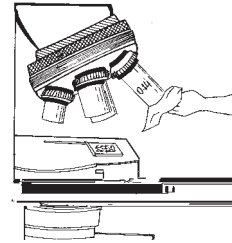

Fig. 9.10

- The cover slip should conform to the specifications for the objective of the microscope. Most oil immersion objectives are corrected for cover slip of 0.17 mm thickness.

10 Don'ts for Good Microscopy

- Do not increase the intensity of the light source beyond the maximum permitted value (Fig. 10.1).



Fig. 10.1

- Do not use bad quality facial tissue or coarse cloth to clean the lens as the coarse fibres can scratch the surface of the lens (Fig. 10.2).

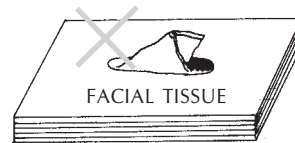

Fig. 10.2

- Never touch electric bulbs with bare fingers. Natural oil from the skin may burn and darken its surface causing premature decrease in light intensity. Use lens paper to hold the bulb when inserting it (Fig. 10.3).

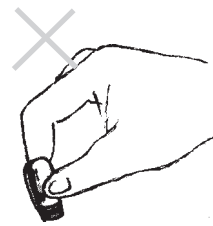

Fig. 10.3

- Do not introduce bubbles into the immersion oil by stirring it, or sucking or expelling the oil violently. A bubble under the objective will cause glare and lower contrast, thus reducing the quality of the image.
- Do not use xylene (or petrol) excessively to clean the lens. Excess oil can be usually wiped off with lens paper or muslin cloth. If good quality immersion oil is used xylene is usually not needed. Avoid using cedarwood oil.
- Do not clean lenses frequently. This may cause scratching and chipping of lenses.

- Do not exchange objectives of two microscopes unless you are certain that their mechanical tube length specifications are identical (Fig. 10.4).

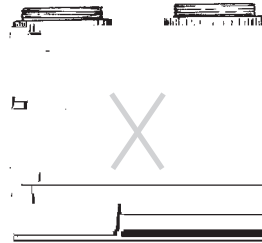

Fig. 10.4

- Do not keep the microscope in a closed space or under a cover in a humid climate without taking precautions against fungal growth. If nothing in this regard can be done, then the microscope should be kept without a cover in a well-ventilated space, preferably under a working fan.

11 Repair/Service

Repairs and service that can be undertaken in the laboratory

The microscope is a high precision instrument and care must be taken to preserve its accuracy. In modern day microscopes, there are not many parts that can be serviced by the user. Proper maintenance of the microscope to avoid damage to its lenses is of prime importance. This chapter summarizes some of the important repairs that can be undertaken in the laboratory.

Electric systems

- Replace blown out fuse.
- Replace burnt out lamp.
- Replace power cord or three-pin plug.

Focus adjustment mechanism

- Tighten the screws controlling the movement of the mechanical stage.
- Adjust the focusing tension as recommended by the manufacturer.

Optical system

- Gently remove the oil which has stuck to or dried on the objectives with lens paper soaked in lens cleaning fluid recommended by the manufacturer. Be careful not to scratch the surface of the lens. If the oil film is hard, repeated applications may be necessary.
- Remove fungus as described in Chapter 8.

Remove dust

- Before cleaning the lens by wiping or rubbing, remove dust with an artist's brush or air brush, otherwise wiping the lenses may cause scratches.
- To remove dust from the outside surface, use a soft camel-hair/artist's brush or an air brush. In case the problem persists, use the lens cleaning fluid recommended by the manufacturer. If this is not available, clean the surface with a soft silk cloth/muslin cloth which has been washed well.
- For dust inside the objective, unscrew it out of the nose-piece and clean with a camel-hair/artist's brush or air brush.
- For dust inside the eye-piece (this happens only if it has been tampered with), unscrew the top-most lens of the eye-piece and remove the dust with the help of camel-hair/artist's brush or air brush. Lenses may also be cleaned with a swab of cotton wool moistened with lens cleaning fluid or distilled water.
- For dust on the surface of the prism, remove the observation tube and clean the surface of the prisms with soft tissue moistened with lens cleaning fluid or distilled water. Never remove the prisms. Clean them in their original position only. Clean the observation tube by blowing air through it.

Never open the prism case or remove the prism. This will completely alter the alignment and the microscope will have to be sent to the manufacturer for repair.

Annex I

Maintenance Record Form

Identification_____ Location_____ Sl. No._____

Year_____

Month	Date	Routine maintenance by
January		
February		
March		
April		
May		
June		
July		
August		
September		
October		
November		
December		

Problem/corrective action _____

Name/address/phone no. of Service Engineer/Dealer/Manufacturer

Annex II

Troubleshooting Guide

Trouble	Cause	Remedy
Light from the source flickers	Loose plug connection at the wall socket, transformer or power supply to the microscope	Secure the loose connections
	Improperly installed light bulb	Reinstall the bulb
	Dirty bulb contacts	Gently file away the crusty deposits at the contacts
	Erratic voltage supply	Use a voltage stabilizer
	Damaged wiring	Fix the faulty wiring
	Faulty on-off switch	Replace the switch
	If there are dark spots on the bulb, the filament of the bulb is likely to burn out	Replace the bulb
Light source does not turn on	Lead of the light source is not plugged in	Plug in the lead
	Light bulb has burned out	Replace the bulb
	Faulty switch	Replace the switch
	Fuse blown out	Replace the fuse
Specimen unevenly illuminated	Light source is not centred	Adjust the centring of the condenser
	Objective is not aligned with the path of light	Gently rotate the nose-piece until it clicks into position

Trouble	Cause	Remedy
Specimen poorly illuminated even at maximum voltage	Iris diaphragm is almost closed/not centred Dirt, or fungal growth	Adjust the opening of the iris diaphragm Gently wipe the condenser lens with lens paper/ soft cloth. If the trouble persists clean with lens paper soaked in xylene, or lens cleaning fluid, or fungus cleaner
	Condenser is too low Heavy fungal growth somewhere on lenses	Raise the condenser Clean the lens using lens cleaning fluid as recommended by the manufacturer
Excessive image contrast	Iris diaphragm is almost closed	Adjust diaphragm opening
Illuminator too bright or too dark	Voltage supply is too high or too low	Ensure proper voltage supply Install voltage protection device
	Bulb is not of standard quality	Use bulb of standard quality as recommended by the manufacturer
Unclear image with glare	Iris diaphragm too far open	Close the iris diaphragm to make the opening narrower
Specimen gets focused at 10x but not at higher magnifications	Specimen slide is placed upside down	Place the slide with the side on which the specimen has been placed facing upward
	Coverslip and mounting fluid too thick	Use coverslip of right thickness and mount properly

Trouble	Cause	Remedy
Poor quality of image with 40x objective	Lens has been accidentally smeared with oil	Gently remove the oil with lens paper or muslin cloth
	Damaged lens	Examine the objective. If it has scratches, nicks or cracks, get it serviced professionally or replace it
	Fungal growth	Clean the lens using fungus cleaning fluid as recommended by the manufacturer
Specimen goes out of focus more than usual at high magnification	Slide is not placed correctly on the stage	Remove the slide, clean the stage of dust and broken glass pieces. Place the slide and clamp gently
Oil immersion objective does not give a clear image	It is being used without oil	Apply immersion oil
	Immersion oil is of poor quality (low refractive index)	Use good quality immersion oil
	Surface of the lens is dirty or oil is inside the objective	Clean lens with lens paper, if required with lens cleaning fluid; replace lens if necessary
	Bubbles in immersion oil	Remove air bubbles
Dust/dirt visible in the field of view	Dust on the collector lens of the light source Dust on the top-most lens of the condenser Dust on the eye-piece	Remove the dust particles with a camel-hair/artist's brush

Trouble	Cause	Remedy
Mechanical stage drops and specimen goes out of focus or stiff up-and-down movement of the stage	Tension adjustment on the mechanical stage is loose or tight	Adjust tension with tension adjustment device
Mechanical stage cannot be raised to its upper limit	Mechanical stage is locked too low	Unlock the pre-focus locking lock, adjust to proper height and lock
Incomplete binocular vision	Eye-pieces are not matched	Use matched eye-pieces
	Improper adjustment of interpupillary distance	Adjust the interpupillary distance
	Diopter adjustment was not done	Make diopter adjustment
Fuse blows out frequently	Faulty (lower rating) fuse	Use proper fuse
	High line voltage	Use voltage protection device
	Defect in the electrical circuit	Get the help of a qualified service engineer